

ATC HeatStat Underfloor Heating Thermostat

Installation And Operation Manual. HS500 - Standard, HS500-WiFi - Connected

Thank you for purchasing the ATC HeatStat wall mounted heating controller, your thermostat is equipped with five touch sensitive buttons across the bottom of the thermostat for easy control and a large easy to read screen that is optimised for viewing from above.

The HS500 is designed for both underfloor heating control with the supplied floor sensor and normal room control using the built in highly accurate room sensor. The Wi-Fi connected version allows control of your thermostat from the Tuya Smartlife platform

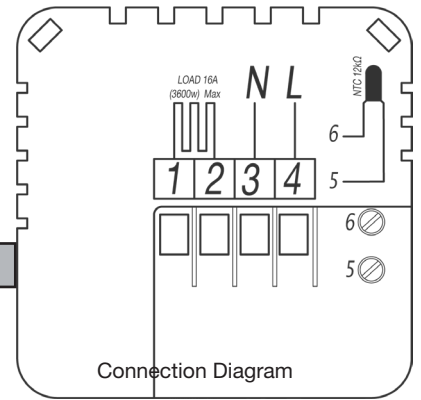

IMPORTANT SAFETY INSTRUCTIONS

1. Read all instructions prior to installing this thermostat, failure to follow the instructions could damage the product or cause a hazardous condition.
2. Check the loading of the product you intend to connect to this thermostat to ensure that the device is capable of switching the intended load. Do not connect the load if it is rated higher than 16A. Product can control a contactor, consult an electrician for installation when using a contactor.
3. After product installation is complete, follow the instructions given below to ensure that the thermostat functions correctly.
4. This product must be installed by a qualified electrician.

MAIN SCREEN LAYOUT INFORMATION

Main Thermostat Screen

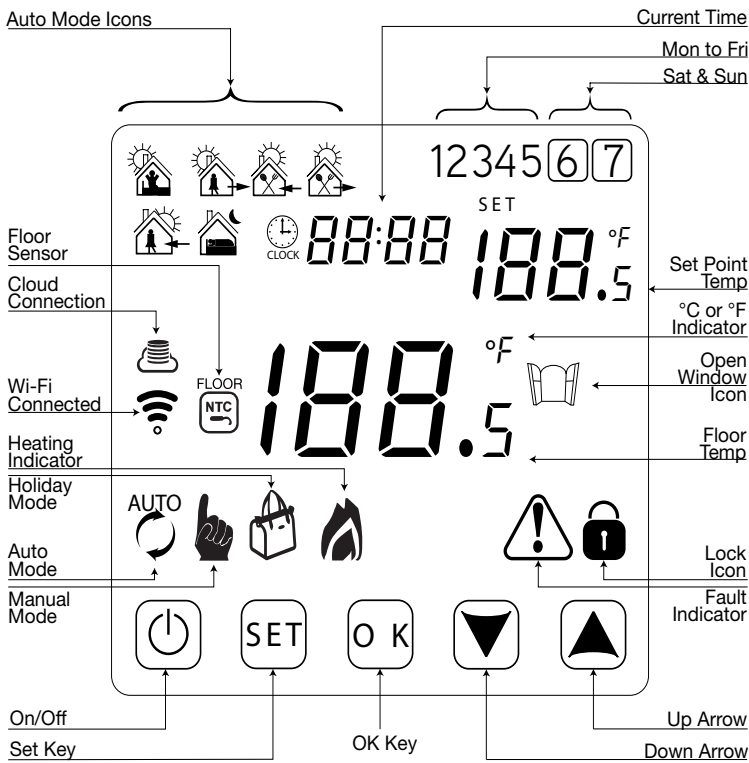

Touch to turn the thermostat on and off.



1. Short touch to switch between Auto and Manual mode.
2. Long touch with Stat turned on enters into Programming mode.
3. Long touch with Stat turned off enters into the Configuration mode.



1. Short touch to enter the time setting mode.
2. Long touch to enter holiday mode configuration.



1. Touch to decrease the temperature set-point.
2. Long touch to lock or unlock the thermostat.



1. Touch to increase the temperature set-point.
2. Long touch to find out the external temperature probe (when in room sensor mode - see #4 in advanced functions).
3. When in Auto mode, touch up or down arrow to temporarily change the temperature set-point and enter into Temporary override mode, Manual Mode icon will show on screen (touch set to return to auto mode).

SETTING THE TIME

To set the current time and day touch the (OK) key and the time will start to flash; set the current minutes using the (Up Arrow) or (Down Arrow) and touch (OK), the hours can now be set in the same way. When the time is correct touch the (OK) key and the days of the week will flash starting at 1 (Monday). Change to the correct day of the week and touch (OK) to save the time. - Note: If using a Wi-Fi version the time is automatically set by the app.



Always disconnect power before installation, Risk of Electric Shock or Equipment Damage.



PROGRAMMING

The ATC HeatStat is factory set in a 5+2 configuration (Monday to Friday & Saturday/Sunday), it can also be set for 6+1 and 7 days all the same (see “*RL*” in the advanced functions). The factory program is set as follows:

Heating Mode Icon													
Function		Wake Up		Leave Home		Return		Leave Home		Return Home		Go to Bed	
Time	°C	06:00	20	08:00	15	11:30	15	13:30	15	17:00	15	22:00	15
HS500		Yes		Yes		No		No		Yes		Yes	
HS500-WiFi		Yes		Yes		Yes		Yes		Yes		Yes	

In order to customise the program touch and hold the **SET** key and the display will change to show the time for the First heating period flashing and the “12345” at the top of the screen. These numbers show that the weekdays are being programmed. Use the & keys to adjust the time (hours then minutes); to move to the next set-point use the **SET** key each time. Once the time is set, then the “Set Point Temp” will begin to flash, set to the required value and press **SET** to store.

Repeat this process for each of the times and temperatures required for each day. Once the Monday to Friday times have been set the **6 7** will begin to flash to indicate that Saturday and Sunday are being programmed. Complete the times and temperatures required. Once the programming has been completed then the thermostat will return to Auto mode as shown by:

, leaving the thermostat alone for 20 seconds will also return to the previous mode of operation. At any time the temperature setting can be adjusted with the & keys and the display will change from Auto to show the Manual Override symbol: . To return to automatic operation touch the **SET** key.

HOLIDAY MODE

To set the thermostat into holiday mode where it will override the standard program for a number of days (1-30 days) touch and hold the **OK** key until the time changes to “OFF”, use either or to change the display to “ON” and touch **OK**. The Main Temperature display will show “*0 1*” change this to the number of days Holiday mode should be active for and touch **OK**. Now the Set Point Temperature will start to flash, change the set-point to the temperature to be maintained for the holidays and touch **OK**. The display will change to show the Holiday Icon: . To return to normal operation touch **SET**.

KEY-LOCK





To lock the keys to prevent any accidental changes touch and hold the key. The display will show the lock icon: . To unlock hold the key until the lock icon disappears.

ADVANCED FUNCTIONS

To configure the thermostat in a different mode to the factory setting, turn the unit off with the key, and touch and hold the **SET** key, there are 14 settings from *R1* to *R9* and *RA* to *RE* as outlined below. To adjust the setting use the or and **SET** to save the value and move onto the next setting. If the thermostat is left for 20 seconds the menu will revert to off.

Note: Manual Mode available in Item *RL*

Item	Function	Description of function and range of information.	Factory Default
<i>R1</i>	Display temperature offset.	-9°C to +9°C. Default will display current temp with 0.5°C Accuracy	Current Temp
<i>R2</i>	Temperature control return difference.	0.5°C to 2.5°C.	1°C.
<i>R3</i>	External sensor, limit temperature control difference	1°C to 9°C.	2°C.
<i>R4</i>	Control type options.	<i>N1</i> : Internal sensor with high temperature protection to turn stat off. (Room Stat) <i>N2</i> : External sensor with high temperature protection to turn stat off (Floor Stat) <i>N3</i> : Internal sensor with external sensor as high level limit (<i>RB</i>). When external temperature exceeds value, relay is turned off. (Room and Floor Stat).	<i>N2</i>
<i>R5</i>	Key Lock.	0 : Does not include Power key. 1 : Includes Power key.	0

<i>R6</i>	High Limit value for external sensor.	Only available when <i>R4=N3</i> Range 20°C→70°C, when set to less than 20°C setting shows "--" and protection is turned off. If the high limit setting is exceeded the relay is turned off and the heating symbol will flash until the temperature falls below the setting.	45°C 
<i>R7</i>	Sensor Low Limit. If <i>R4=N1</i> Internal sensor, if <i>R4=N2</i> External sensor	Range 1°C→10°C, (anti freeze protection). When set to more than 10°C setting shows "--" and protection is turned off.	5°C
<i>R8</i>	Lowest settable temperature.	1°C to 10°C.	5°C
<i>R9</i>	Highest settable temperature.	20° to 90°C. HS500 Standard / 20° to 70°C HS500-WiFi. (Use this setting for wooden floors, set to 28°C).	35°C
<i>RR</i>	Descaling function.	0 : Descaling function off. 1 : Descaling function on. If output is continuously closed for 100 hours or more, contact is open for 3 minutes.	0
<i>Rb</i>	Function after power loss.	0 : After power loss, thermostat returns to previous state (off/on) after power is restored. 1 : After power loss, thermostat returns to off after power restored. 2 : After power loss, thermostat returns to on after power restored.	0
<i>RE</i>	Type of Programming selection.	0 : 5+2 (Mon→Fri, Sat & Sun). 1 : 6+1 (Mon→Sat, Sun). 2 : 7 (7 Days all the same). HS500 ONLY 3 : Manual mode, No program functions, only  or time and arrows for temperature. Note: HS500-WiFi manual mode in app does not have a related setting but will function	0
<i>Rd</i>	Open Window mode- off duration.	5 to 60 minutes. If temperature drops 3°C in 30 minutes the relay is deactivated for the set duration and display shows  . To reset whilst function is active turn stat off and on again. (If setting is set to less than 5 minutes, shows "--" and function is disabled).	30
<i>RE</i>	Factory Reset.	Display shows <i>Rd</i> , press and hold  . Display shows all icons and then switches off. All settings apart from time are lost.	<i>Rd</i>

SENSOR FAULT

The thermostat may show an *E1* or *E2* on the display. This is because the sensor is not connected correctly; it may be due to an open circuit or the heat mat may be connected in terminals 5 and 6. Check the resistance of the sensor, it should be 12kΩ@25°C. If the mat was inadvertently connected in 5&6 the resistance would be between 21Ω and 756Ω, these low resistances will cause the thermostat to display an error. Once the resistances are checked, replace the sensor or mat as appropriate.

INSTALLATION METHOD

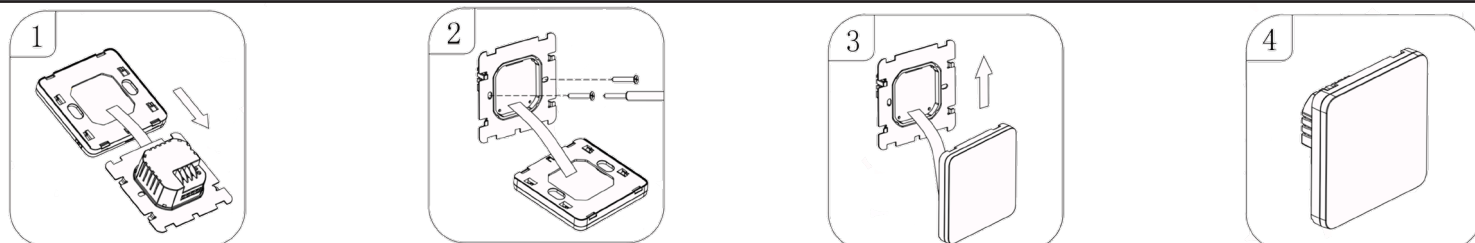

WARRANTY

ATC Electrical and Mechanical provides a limited one year warranty for the HS500 thermostat as long as the unit has been installed, used and maintained in accordance with the information provided in this manual. In order to arrange a replacement thermostat, the information listed below is required. It is recommended to write this information below and keep this instruction manual in a safe place.

Date of Purchase: _____ Location Purchased: _____





SPECIFICATIONS

Model	HS500	HS500-WiFi
Power	220-240V AC 50/60Hz	
Temperature Range	0° to 40°(Display), 5° to 35°(Adjustment)	
Display accuracy	0.5°C	
Sensor type	Internal 10kΩNTC, External 12kΩNTC @25°C	
Program type	4 on/off per day(5+2)	6 on/off per day (5+2)
Switching capacity	16A Resistive. 1A Inductive (Relay)	
Wi-Fi Band	N/A	2.4Ghz
Installation type	Wall Mounted	

App Connection

Download and install the “Tuya Smart life” APP for Android or iOS or scan the QR code to download and install it, create an account according to the instructions in the app or log into your existing account. .



Touch  to power on the thermostat, when the screen comes on, Touch and hold  and  together. The  and  symbols will begin to flash indicating that the thermostat is in pairing mode.

Open the APP (connect the phone to 2.4Ghz Wi-Fi and ensure that Bluetooth is turned on).

Click Add Device to automatically discover the heater and click Add.

Enter the Wi-Fi network password of the current phone connection (2.4Ghz WiFi Connection), click Next as shown Once the thermostat has connected to the app correctly touch “done” it will then show the operation screen. Follow the icons at the bottom of the screen to operate the thermostat.

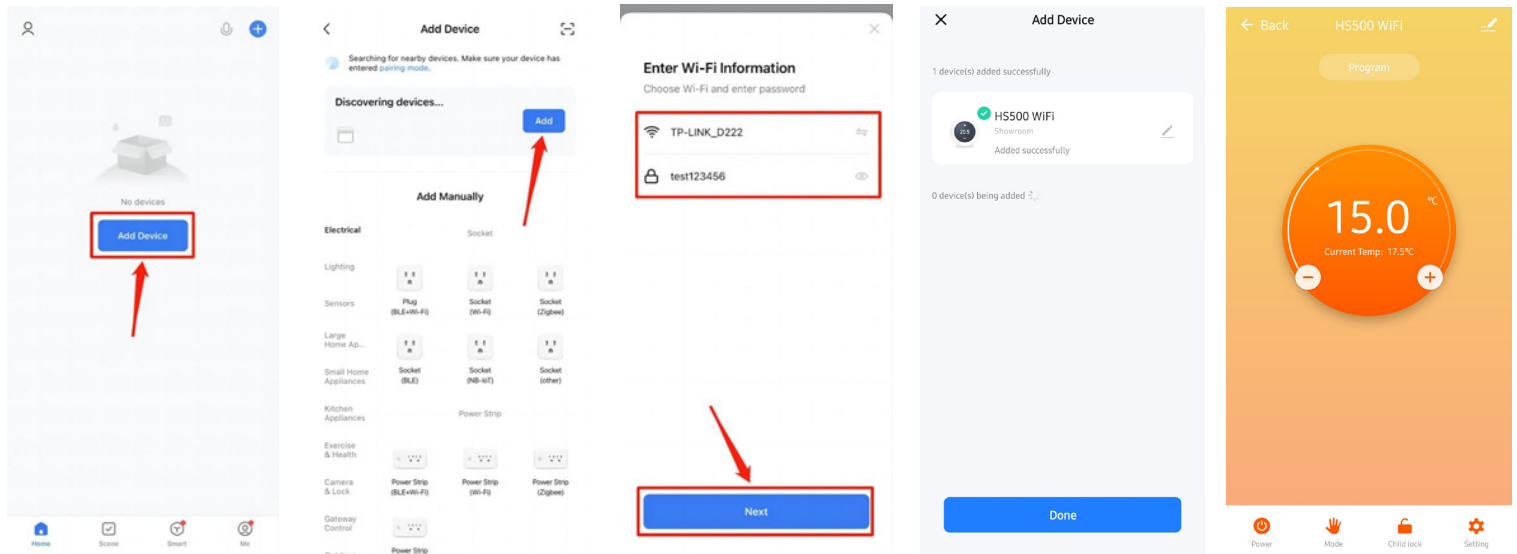

END OF LIFE INFORMATION

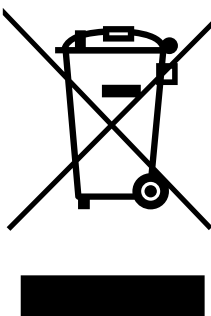

This marking shown on the product and its literature, indicates that it should not be disposed of with other household wastes at the end of its working life. (Crossed Wheelie Bin)

To prevent possible harm to the environment or human health from uncontrolled waste disposal, please separate this appliance from other types of wastes and recycle it responsibly to promote the sustainable reuse of material resources.

Household users should contact either the retailer where they purchased this product, or their local government office, for details of where and how they can take this item for environmentally safe recycling. Business users should contact their supplier and check the terms and conditions of the purchase contract. This product should not be mixed with other commercial wastes

Waste Electrical & Electronic Equipment (WEEE)

Applicable in the European Union and other European countries with separate collection systems

Distributed by:
 ATC Ltd.
 ATC House,
 Broomhill Drive
 Tallaght
 Dublin D24 EF99



Email
Sales@atc.ie
 Tel :
 +353 1 467 8301
 +44 203 564 9164

