

ATC SOMERSET PANEL HEATER INSTALLATION AND OPERATION MANUAL

SPH500	500w Somerset Panel Heater
SPH750	750w Somerset Panel Heater
SPH1000	1000w Somerset Panel Heater
SPH1500	1500w Somerset Panel Heater
SPH2000	2000w Somerset Panel Heater



This product is only suitable for well insulated locations or occasional use when used as a portable heater.



EcoDesign
Compliant

NOTE: The installer should review the contents of this manual with the owner on completion of the installation.

CONTENTS

Contents	2
Important Safety Instructions	2
Electrical Installation notes	3
Wall Mounting Instructions	4
Controls and Icons	6
Basic operation and Count down	7
Changing Modes	7
Setting the time	7
Setting a Program	8
Open Window Detection	8
Key lock	9
Sounds	9
Program Reset	9
Display Temperature Offset	9
Maintenance	9
Castors	10
Technical Specifications	10
Warranty	11
End of life and disposal information	11
Eco-Design Information	12

IMPORTANT SAFETY INSTRUCTIONS

These instructions should be carefully read before installation and retained by the user. The booklet must be kept and delivered to the new user in case of disposal of the heater. The Manufacturer reserves the right to vary the features of the product without prior notice. The technical data are indicative only.

1. This heater is intended solely for the use it has been designed for, namely space heating. The Manufacturer or Distributor is not responsible for any damage that could happen due to improper use.
2. After unpacking make sure that the heater is complete and shows no signs of tampering or any visible damage
3. Keep packing materials, which are potentially dangerous, away from children.
4. The heater can be used by children of at least 8 years (as well as by persons with reduced physical, sensory or mental capabilities, or lack of experience or required knowledge) provided that they are under supervision, or after they have been instructed relating to the safe use and have understood the potential dangers.

5. Children should not play with the Heater.
6. Cleaning and maintenance must be performed by the user and not by unsupervised children.
7. Children of less than 3 years should be kept away unless continuously supervised.
8. Children aged from 3 years and less than 8 years shall only switch on/off the heater provided that it has been placed or installed in its intended normal operating position and they have been given instruction concerning use of the heater in a safe way and understand the hazards involved, children should always be supervised.
9. Children aged from 3 years and less than 8 years shall not plug-in, regulate, clean the heater or perform maintenance.
10. Before connecting the heater make sure that the voltage is the same as indicated on the device rating label.
11. Do not use in presence of gas, inflammable or explosive liquids or substances as defined in BS5345.
12. Some fundamental rules which apply to all electrical devices must be observed when using the heater:
 - Do not touch the heater with wet hands.
 - Do not handle the heater when you have bare feet.
 - Do not let children play with the heater.
 - Avoid the use of extension cords with this product, extension cords may overheat and there could be a risk of fire.
13. Do not make any modification to the Heater.
14. Keep connections dry.
15. If the power supply cord is damaged, do not use the heater until the cord has been replaced. For power cord replacement, always contact an electrician in order to avoid any risk of injury.
16. If the heater is not going to be used for a long period, disconnect it from the power supply.
17. Always disconnect the heater before doing any maintenance.
18. **CAUTION - Some parts of this product can become very hot and cause burns. Particular attention has to be given where children and vulnerable people are present.**



ELECTRICAL INSTALLATION NOTES

The installation should always be carried out by a qualified electrician or a competent person in accordance with the current electrical standards: HD 384 CENELEC for Mainland Europe, IEC 60446 and BS 7671 for the United Kingdom, IEC 60445(2010) & ET101:2008 for Ireland and IEC 60364-7-708 1988 internationally. The energy supply to the heater must always be properly earthed. The heater must be connected to the energy supply using the provided cable.

An over voltage category III Combined Circuit breaker and Residual Current Device (RCD) with rated earth leakage operation not exceeding 30mA must be fitted upstream on the supply line. The circuit breaker must have a contact opening distance of at least 3 mm.

- The heaters should always be installed only using the mounting brackets provided or optional castors if purchased separately.
- Under no circumstances turn the heater on if it is not mounted using the brackets

- supplied, the original castors accessory or if the face of the heater is flat on any surface.
- The heater must not be recessed in the ceiling. There must be enough space around the top of the heater to ensure adequate ventilation.
 - A minimum air gap of at least **100 cm** should always be allowed between the top of the heater and a ceiling or roof and **20 cm** to any ledge or trunking above the heater.
 - The heater should be at least **60 cm** away from any surrounding walls.
 - A distance of at least **100 cm** should always be left in front of the heaters to ensure safety
 - The Heater should be mounted at a minimum of **15cm** to the bottom of the heater above floor level.
 - The Heater must not be located either directly below, or in front of a socket-outlet.
 - The Heater must be installed so as to prevent any control switches being able to be touched by anyone who is in the shower or bath.
 - Make sure that there is no possibility of inflammable material, combustible material or curtains coming into contact with the heater, there is a risk of fire if this happens.

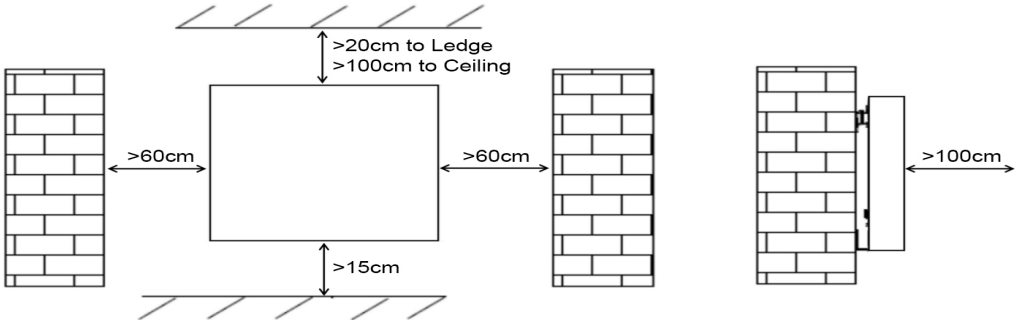

WALL MOUNTING INSTRUCTIONS

Remove the heater from the outer packaging and then remove the wall brackets from the heater. It is recommended to lay the heater down with the protective polystyrene in place to protect the face of the heater.

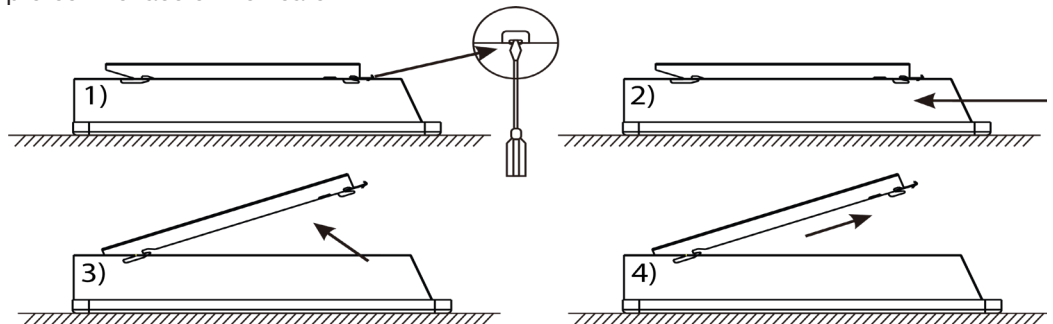

- 1) Lift the locking tab with the screwdriver,
- 3) Lift the Top of the bracket away from the heater

- 2) Push the bracket toward the base of the heater.
- 4) Remove the bracket.

Mark the wall according to the dimensions given below for the heater of your size.

Kw	0.5/0.75 /1.0	1.5	2.0
A/B	218		
C	179	303	442

All dimensions in mm

Drill the wall and insert the plastic wall anchors provided into the holes.

Mount the wall bracket using the screws provided ensuring that the screws are securely holding the bracket to the wall and there is no movement in the bracket.

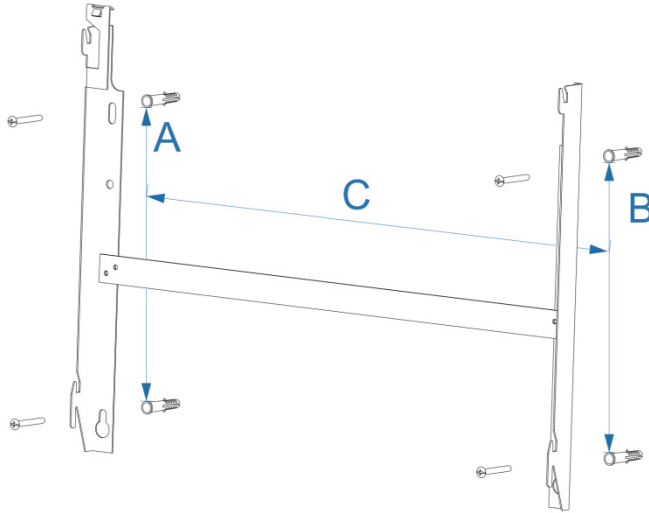

Note: Prior to drilling the wall, ensure there are no cables or pipes within the wall.

After mounting the wall bracket ensure that the mounting screws are fixed firmly to guarantee that the heater is safely mounted to the wall.

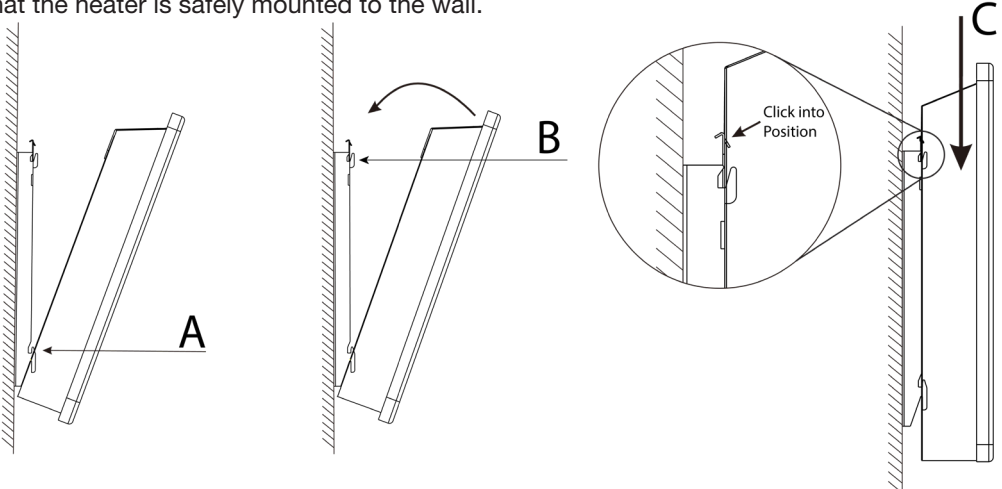

To mount the heater onto the wall, tilt the heater so the bottom holes in the rear of the heater are aimed at the lower mounting hook and attach the heater on to the bracket (A). Rotate the heater towards the wall until the upper hooks enter the upper mounting holes (B) Push the heater down on the brackets (C) until a click is heard and the latch is in place.



DO NOT COVER THE HEATER.

CONTROLS AND ICONS

The Somerset panel heater is equipped with an LCD screen and 6 touch sensitive buttons to allow easy programming.

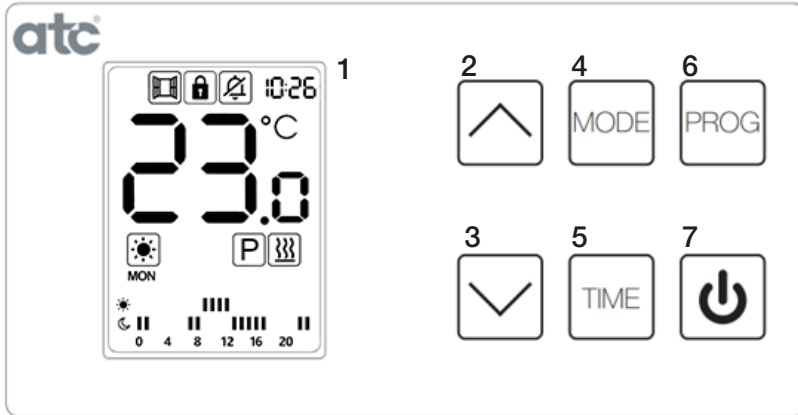

- 1: Screen
- 2: Up Arrow
- 3: Down Arrow
- 4: Mode Key
- 5: Time Key
- 6: Program Key
- 7: Standby Key

What the icons mean:



The Sun symbol indicates the Comfort mode is active - the comfort temperature can be set when this symbol is showing



The Moon symbol indicates the Economy mode is active - the economy temperature can be set when this symbol is showing. Economy is *always at least* 1°C less than the Comfort setting. If Comfort is changed and set below the existing Economy setting then the Economy will be amended to be 1.0° less than the Comfort setting.



The Snowflake symbol indicates Anti-frost mode and is factory set at 7°C and cannot be adjusted. Anti-frost is normally used as “off” in Program mode.



The P Symbol indicates that the heater is running in the Program mode. Entering the program and setting the time is also carried out in Program mode.



The three wavy lines indicate that the heating element is turned on and that the room has not reached the set point. When the room reaches the temperature set in Comfort or Economy mode the heating symbol will turn off.



The Window symbol indicates that the open window mode has been turned on. See open window section for more information.



The Crossed Bell Symbol indicates that the key sound is turned off.

BASIC OPERATION AND COUNTDOWN

To turn the heater on, press the Standby key , on initial start up the heater will default into Comfort mode with a temperature of 22°C.





The screen will always show the current set point temperature. If the room is colder than the current mode set-point then the heating icon will be shown.

Comfort Mode can be set from 9°C to 35°C, Economy mode can be set from 8°C to 34°C. Anti-frost is factory set at 7°C.



In any of the manual operation modes there is a countdown available. At the end of the countdown the heater will enter standby mode and remain in standby until the heater is manually reactivated.



Economy Mode



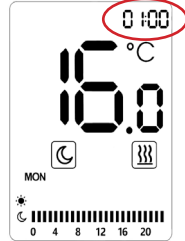

To activate the countdown touch the  (time) button and the “00”:00 of the clock will flash, enter the number of hours to countdown with the  or  arrows and then touch  to save.

The Maximum time for the countdown mode is 24

hours. To cancel a countdown, touch the  button and set the clock back to 00:00 and touch  to exit back to manual mode.





CHANGING MODES

There are 4 operation modes on the Somerset panel heater, Anti frost , Comfort , Economy , and Program mode .

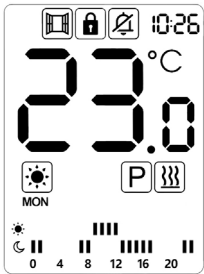

Switch between each mode using the .



SETTING THE TIME



When entering the Program mode, the currently programmed heating mode icon will also display; i.e. if the programmed mode is anti-frost then the display will show both icons. e.g.:  

Select the program mode as described above, when the P is displayed on the screen press the  button, the day of the week will begin to flash.

Select the correct day of the week using the  or  buttons. Once the correct day is selected, press the  button and the hours (“00”:00) on the display begins to flash.

Set the hour, press  and the minutes (“00”:00) begin to flash, set the minutes and then press  to complete the time setting process.

NOTE: The time is only maintained when the heater is powered, when the power is removed from the heater the time is reset.

SETTING A PROGRAM

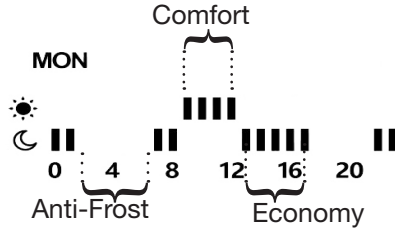

When the heater is running in Program mode and the time and day has been set the heater can be programmed. To begin press the **PROG** button and the **P** icon will begin to flash, select the day of the week that needs to be programmed with the **TIME** button.

Once the correct day is selected use the or buttons to move the flashing bars to the start of the day.

Each segment of the program display is 1 hour and can be set to Comfort (the top half of the segment), Economy (the bottom half of the segment) or Anti-frost (shows no segments); each of the heating modes shows the corresponding icon (see page 7) when it is programmed.

To change which heat mode is used during programming is carried out by pressing the **MODE** button, each press will cycle through Comfort, Economy and Anti-frost.

When the flashing segment is at the start of the day, select which mode is required and use the or buttons to move forward - each hour will be programmed with the selected heating mode, the mode will remain the same until it is changed.

When the end of the day is reached the flashing segment will revert to the start of the day, when this happens, press the **TIME** button to move forward to the next day.

To copy the complete program from the previous day, press and hold the **PROG** button until a beep is heard, the display will change to show the copied program, press the **TIME** button to move forward to the next day to continue programming, complete the programming for the week and press the **PROG** button to exit programming mode and leave the heater in Program run mode (**P** icon on the screen).

NOTE: Programming mode will return to Program Run mode 10 seconds after the last button press.

Please note it is only possible to copy the program from the previous day.





OPEN WINDOW MODE

The Somerset panel heater has energy saving Open Window mode built in, the display will show the icon when the mode is turned on. To turn the open window mode on or off hold down the **MODE** button until a beep is heard, the icon will turn on or off. Open Window works when the heater detects a 5°C drop in temperature in 20 minutes in the room.



Temperature drops of this type are normally caused by open windows or doors, when a 5°C drop in temperature is detected the heater will stop heating to prevent energy being wasted and flash the icon. When the icon is flashing hold down the **MODE** button to turn the open window function off and re-activate the heating mode.

If Open Window mode is still required, hold the **MODE** button to turn Open Window back on.



KEY LOCK

The Somerset panel heater has a built-in lock to prevent any accidental changes. The Key-lock is activated by holding the  and  buttons together until a beep is heard and the  icon is shown on the screen. When the heater is locked none of the buttons will function until it is unlocked. The heater is unlocked in the same way by holding the  and  buttons together until a beep is heard.



SOUND

The Somerset panel heater will beep each time a key is touched. To turn to turn this sound off touch and hold the  button until a short beep is heard and the  icon shows on the display. Each time the buttons are touched together will turn the sound on or off.
NOTE: *Many of the functions in the Somerset panel heater make a short beep to indicate that they have turned on or off. These Beeps are not affected by turning the sound off and cannot be silenced.*

PROGRAM RESET

Occasionally it may be necessary to reset the Somerset panel heater to remove any programs that may be set. To complete this process press and hold the  and  button together until the heater turns itself off and the screen goes blank.
NOTE: *This process cannot be undone.*

DISPLAY TEMPERATURE OFFSET

Sometimes the Somerset panel heater may turn on and off at a different temperature to a thermostat near the heater. The Somerset heater does not display the room temperature but the operation set point of the heater can be offset to match the other sensing device. To offset the temperature press and hold the  button until the display changes, use the  and  buttons to change the setting of the operation set-point. The offset of the temperature set-point is adjustable from -9° to +9° in 1.0° steps.

MAINTENANCE

The Somerset panel heaters contain no user serviceable parts and therefore require very little maintenance. Ensure that there is no excessive build-up of dust/dirt on the heater element as this can cause overheating and premature element failure.

IMPORTANT

Failure to keep the Somerset Panel heater clean may result in dust becoming burnt and depositing on the wall above the heater in the form of dark streaks or patches. This type of marking is expressly due to failure to keep the heater and surrounding area clean. ATC take no responsibility for any such damage caused.

To clean the outside of the appliance, wipe off dirt with a damp cloth.

Do not use any aggressive cleaning agents. Do not immerse the heater in water or any other liquids.

OPTIONAL CASTER INSTALLATION INSTRUCTIONS

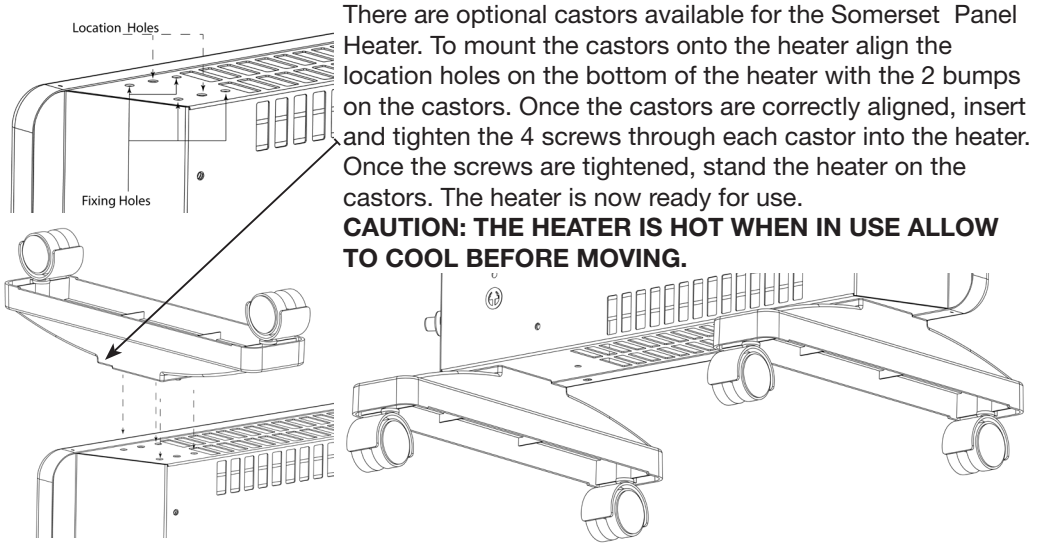

There are optional castors available for the Somerset Panel Heater. To mount the castors onto the heater align the location holes on the bottom of the heater with the 2 bumps on the castors. Once the castors are correctly aligned, insert and tighten the 4 screws through each castor into the heater. Once the screws are tightened, stand the heater on the castors. The heater is now ready for use.

CAUTION: THE HEATER IS HOT WHEN IN USE ALLOW TO COOL BEFORE MOVING.

TECHNICAL SPECIFICATIONS

Product Code		SPH500	SPH750	SPH1000	SPH1500	SPH2000
Power (W)	Watts	500	750	1000	1500	2000
Voltage (V)	Volts	230	230	230	230	230
Frequency (Hz)	Hertz	50	50	50	50	50
Thermostat	Electronically Adjustable between 5° and 35°C					
Safety Cut-Out Temperature	(°C)	110°C	110°C	120°C	110°C	110°C
Weight	(kg)	2.8	2.8	2.8	3.9	4.3
Dimensions (mm)	Width	475	475	475	615	755
	Depth	80				
	Height	420				
	Depth with Bracket	105				
IP Protection	IP	24				
Colour	White					
Approvals	CE, UKCA					
Eco-Design Lot 20 Compliant	Yes					
EAN Barcode		0793591589824	0793591589831	0793591589848	0793591589855	0793591589862

WARRANTY

Your appliance is guaranteed for 2 years from the date of purchase – during this period we will repair or exchange, at our discretion, any faulty or defective parts providing the appliance has been used and maintained in accordance with the operating & installation instructions and has not been misused or mistreated in any way.

The original warranty will continue to apply to any products replaced under the warranty, any new product will not come with a new warranty period.

Any unauthorised repair or attempted repair will invalidate the guarantee. You may be asked to return the product to our workshop for inspection to establish whether the fault is covered under the guarantee.

Carriage to and from the workshop is not covered under the guarantee. Any damage caused by transit must be claimed from the transport supplier. Transport damage is not covered by this guarantee

The guarantee is valid in the UK and Ireland only. This guarantee is additional to your statutory rights. In the unlikely event of a problem with your appliance please contact your supplier.

END OF LIFE INFORMATION

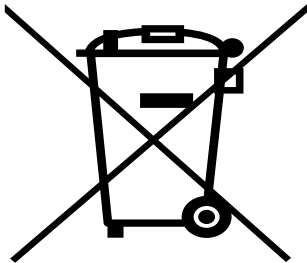

This marking shown on the product and its literature, indicates that it should not be disposed of with other household wastes at the end of its working life. (Crossed Wheelie Bin)

To prevent possible harm to the environment or human health from uncontrolled waste disposal, please separate this appliance from other types of wastes and recycle it responsibly to promote the sustainable reuse of material resources.

Household users should contact either the retailer where they purchased this product, or their local government office for details of where and how they can take this item for environmentally safe recycling.

Business users should contact their supplier and check the terms and conditions of the purchase contract. This product should not be mixed with other commercial wastes

Waste Electrical & Electronic Equipment (WEEE)

Applicable in the European Union and other European countries with separate collection systems

ECO DESIGN INFORMATION

Item	Symbol	Value						Unit	Item	Unit
Heat output								Type of Heat output/room temperature control (select one)		
Nominal Heat output	P_{nom}	0.5	0.75	1.0	1.5	2.0	kW	Single stage heat output and no room temperature control	[no]	
Minimum heat output (indicative)	P_{min}	N/A	N/A	N/A	N/A	N/A	kW	Two or more manual stages, no room temperature control	[no]	
Maximum continuous Heat output	$P_{max,c}$	0.467	0.701	0.937	1.421	1.835	kW	With mechanic thermostat room temperature control	[no]	
Power consumption								Electronic room temperature control plus day timer		
In off Mode	P_o	N/A						kW	Electronic room temperature control plus week timer	[yes]
In standby mode	P_{sm}	N/A						kW	Other control options (multiple selections possible)	
In idle mode	P_{idle}	N/A						kW	Room temperature control, with presence detection	[no]
In network standby	P_{nsm}	0.00098						kW	Room temperature control, with open window detection	[yes]
Standby mode with display of information or status								[yes]	Distance control option	[no]
Seasonal space heating efficiency	$\eta_{s,on}$	Portable:94.5 Fixed: 94.0						%	Adaptive start control	[no]
Efficiency in active mode									Working time limitation	[no]
Contact Details	ATC ATC House, Broomhill Drive, Tallaght, D24 EF99, Ireland.						UK Tel: +44 (0)203 5649164 Tel: +353 (0)1 467 8301 Email: sales@atc.ie Email UK: sales@atcelec.co.uk		Black bulb sensor	[no]
									Self learning functionality	[no]
									Control accuracy	[no]

